

Kensington 1495

L 1495 x W 785 x H 610 mm

Royce Morgan



FA

FC

FF

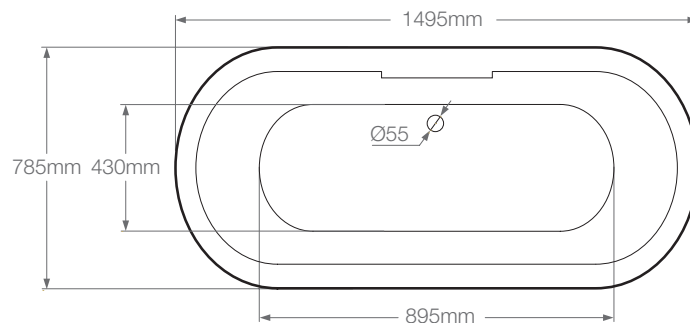
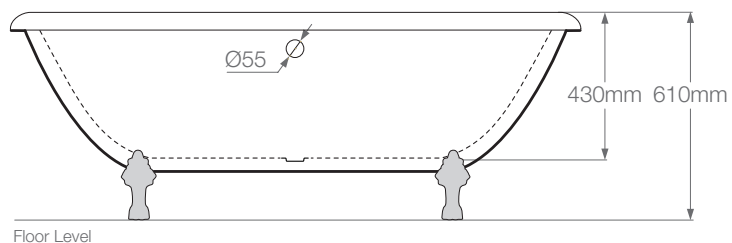

General Specification

Litres to overflow: 165 litres

Weight: 33kg

Weight (with water): 198kg

Feet: FA | FC | FF

Tap Holes: Can be drilled on request

Lifetime Guarantee (*Terms & Conditions apply*)

Recommended Waste

W1: Exposed Chain Waste

W2: Complete Kit Chain Waste

W3: Complete Kit Pop-up Waste

W4: Concealed Chain Waste

W6: Exposed Pop-up Waste

W7: Extended Concealed Pop-up Waste

Accessories

RMFKIT01: Feet Fixing Kit