

SPECIFICATION SHEET

COLLECTION: CELSIUS

PRODUCT CODE: CEL-1701-1/2-11-C/P



DESCRIPTION:

Celsius

- exposed round thermostatic 1/2" shower valve
- Evolve 4 function slide rail shower kit
- easy-fit wall mounting brackets

thermostatic cartridge V-001C-PLA

flow cartridge C-202-RTC

minimum operating pressure 0.2 bar LP

kit comprises:

EVO-MFSRK-DB-C/P

CEL-149-1/2-C/P

WG-049BRACK+SHR-C/P

FINISH:

Chrome

FLOW REGULATOR:

FR-SHOWER/9-C/P

MINIMUM OPERATING PRESSURE:

0.2 bar LP



tel: 01934 744466

email: sales@vado.com

www.vado.com

where inspiration flows

taps | showering | accessories



TECHNICAL DRAWING

COLLECTION: CELSIUS

PRODUCT CODE: CEL-1701-1/2-11-C/P

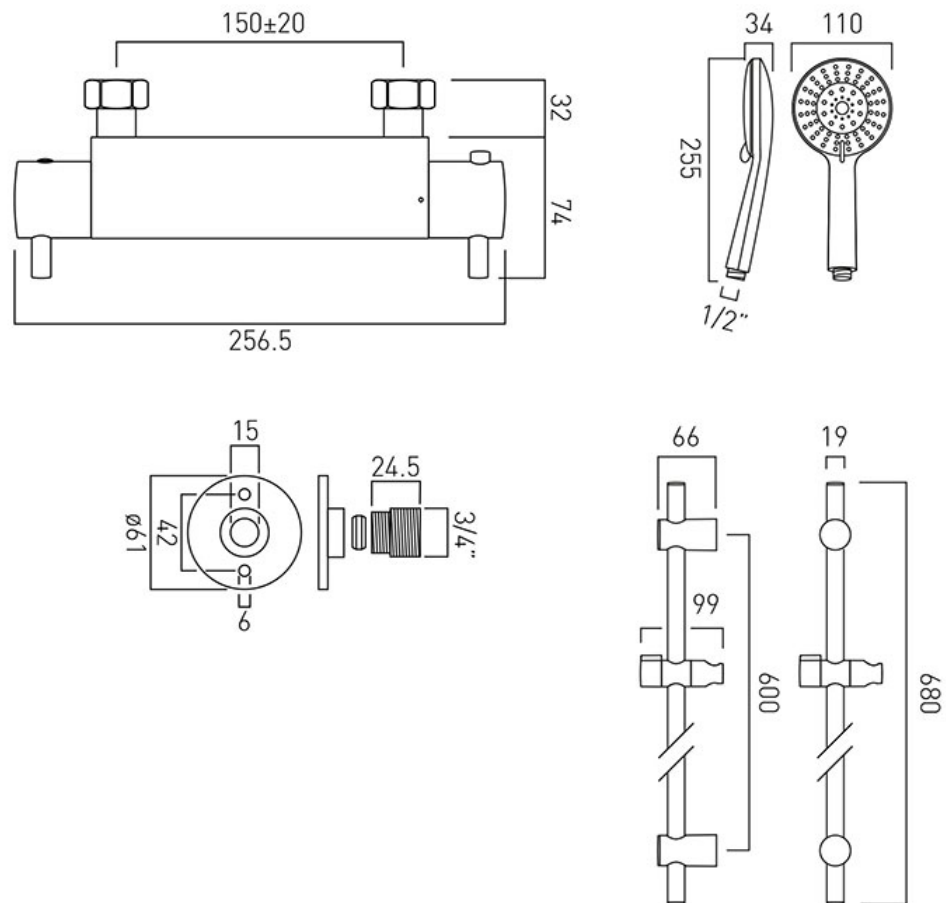

tel: 01934 744466
email: sales@vado.com
www.vado.com

where inspiration flows
taps | showering | accessories

