

# CAMDEN SE

L 1650mm  
W 700mm

	5mm	CODE	CARRONITE	CODE
<b>CAMDEN SE</b>	<b>£251</b>	02557	<b>£465</b>	02558
L-SHAPED PANEL 1650x700x515	-	-	£265	02531
FRONT PANEL 1650x515	£92	02282	£133	02268
END PANEL 700x515	£73	02285	£96	02271
SCREEN CFS-1 (H=1400MM)	£122	02344	£122	02344
SCREEN CFS-2 (H=1500MM)	£135	02346	£135	02346

New  
Bath

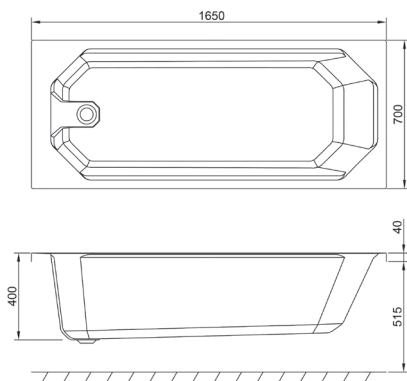

Carronite



Panel

## WATER CAPACITY

200 LTR

This measurement is taken to the overflow

## WHIRLPOOL COMPATIBLE

N/A

## KIT REFERENCES

STANDARD - AK-01

CARRONITE - AK-01-C